

# Bauanleitung – Spur 0 – 1:43,5 Haltepunktgebäude „Weißenohe“



## Benötigtes Material:

Vierkantstab, 4 x 4 mm, gebeizt  
Vierkantstab, 2 x 4 mm, gebeizt  
Holzplatte, 1,6 mm Wandstärke  
Architekturkarton, 4 mm Wandstärke  
Biberschwanz-Dachplatten  
Firstziegel  
Reste aus der Bastelkiste

Diese Bauanleitung bezieht sich auf einen Artikel von Willy Kosak in „Eisenbahn JOURNAL“ 3/1986, S. 64–68

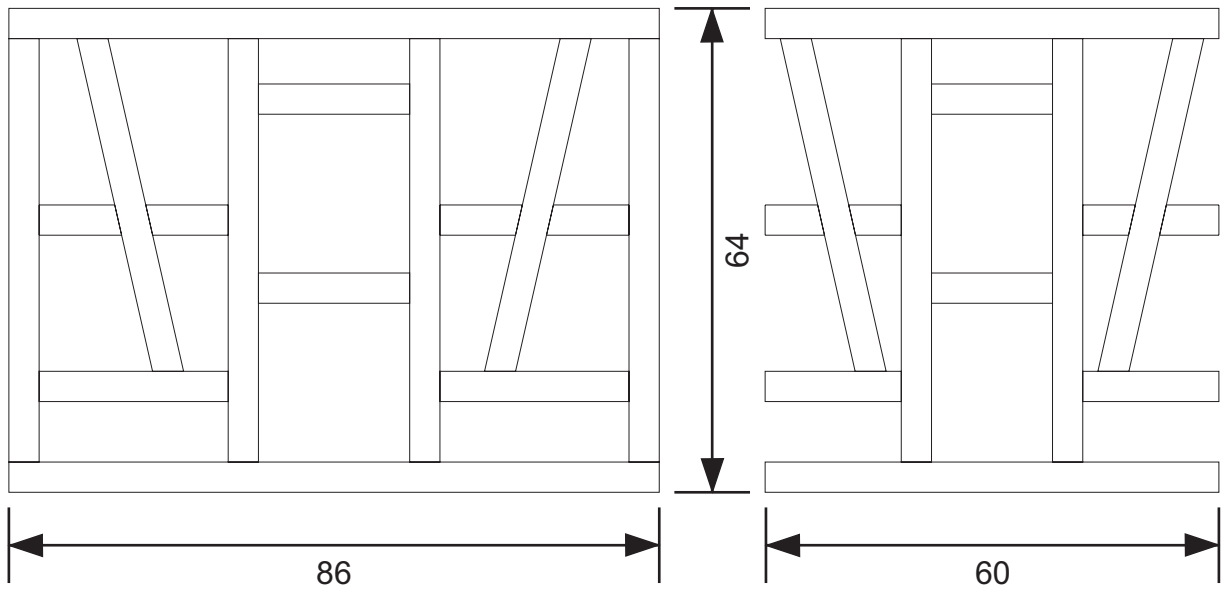

Vierkantstab, 4 x 4 mm, gebeizt

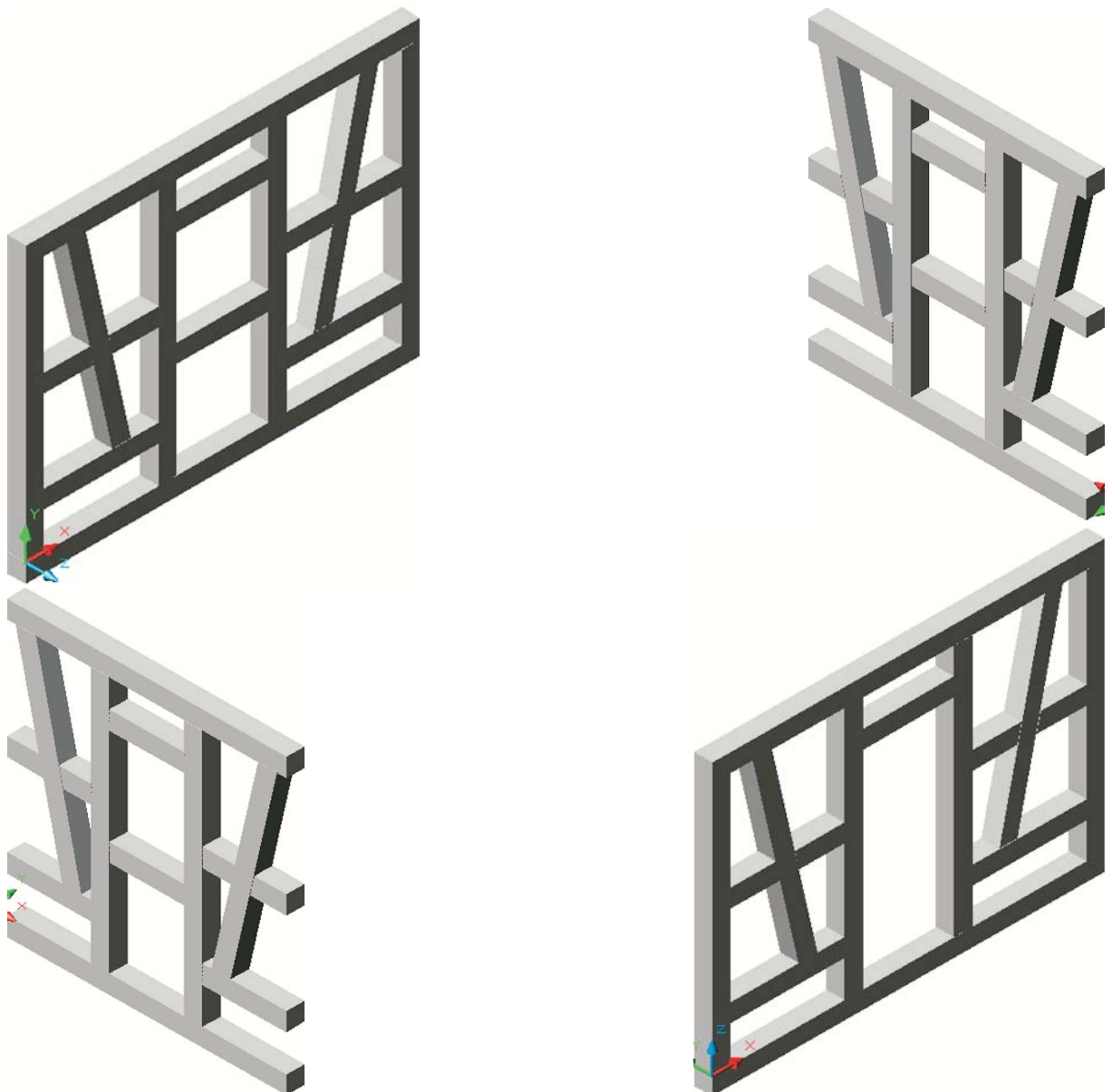

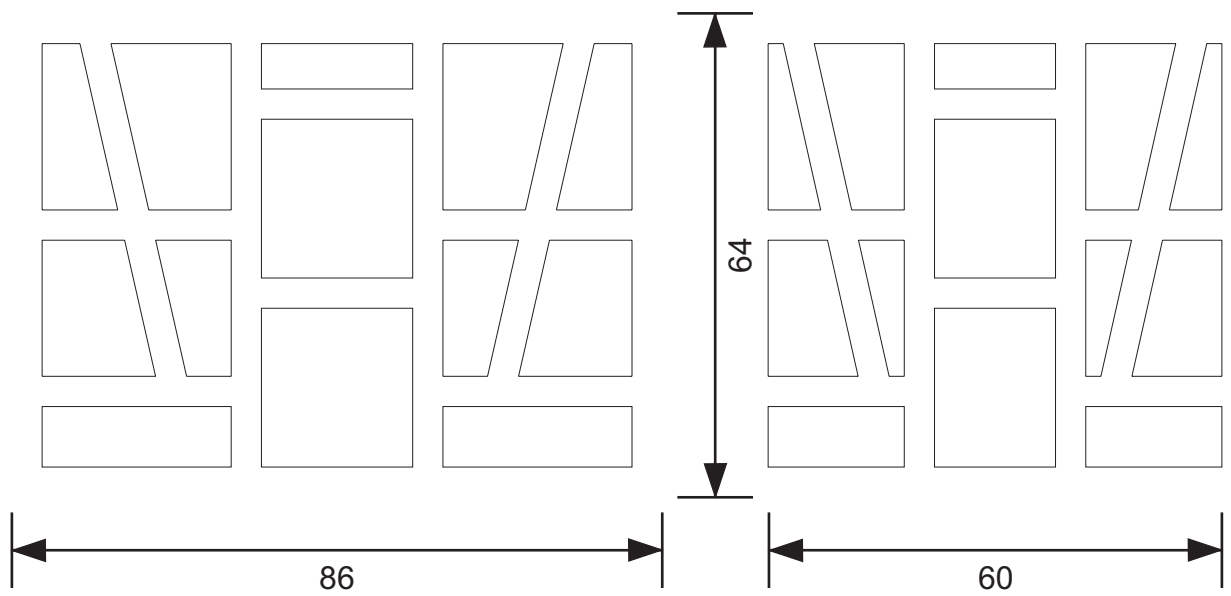

Architekturkarton, 4 mm Wandstärke

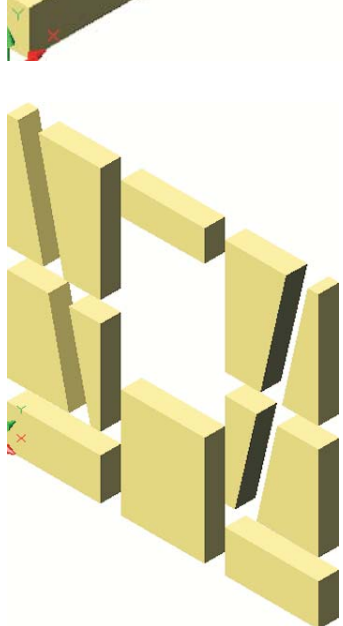
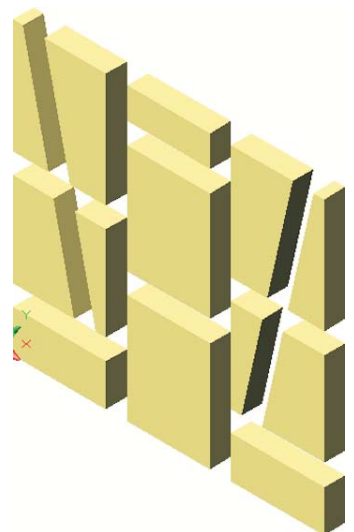
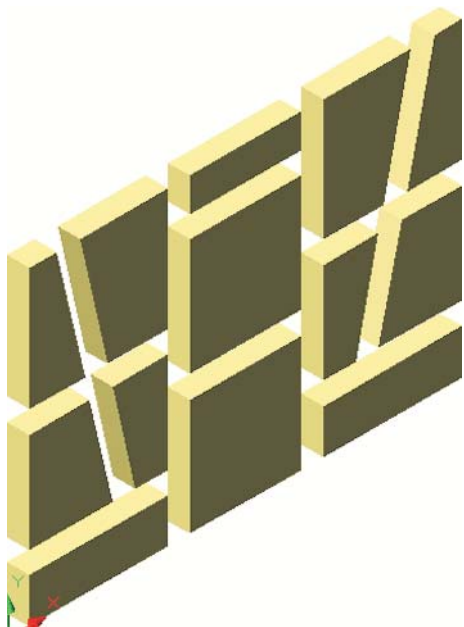

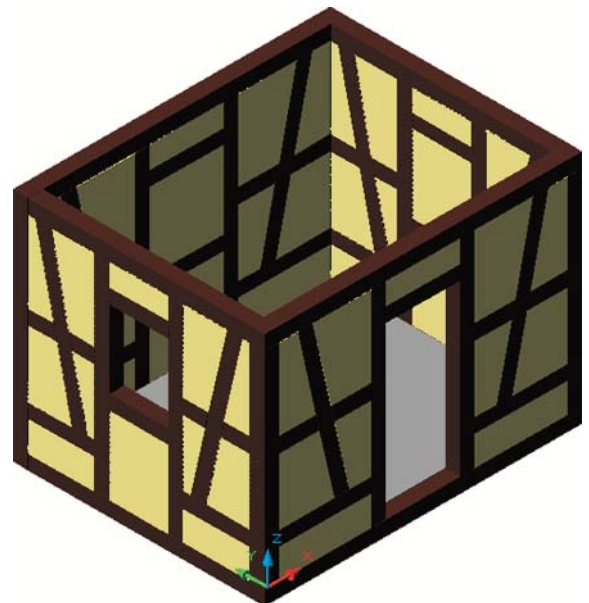
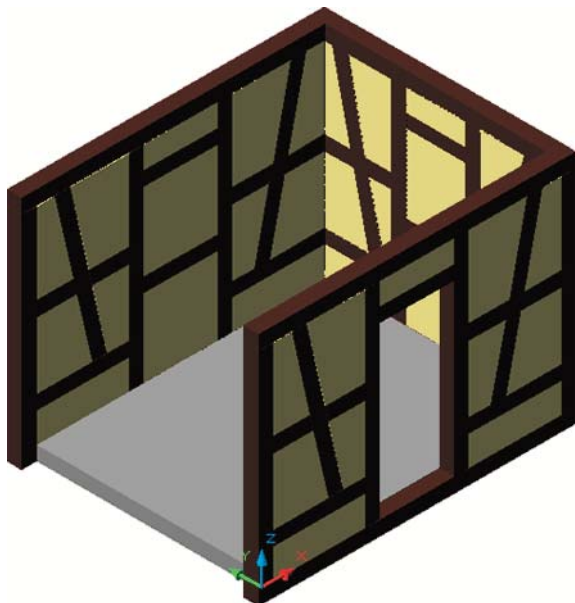
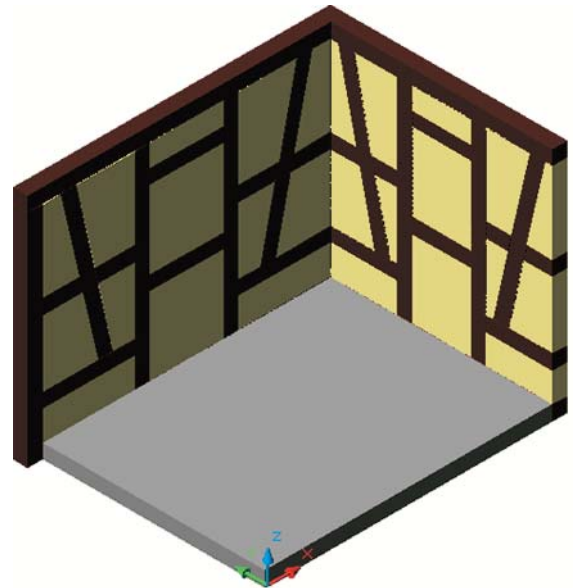
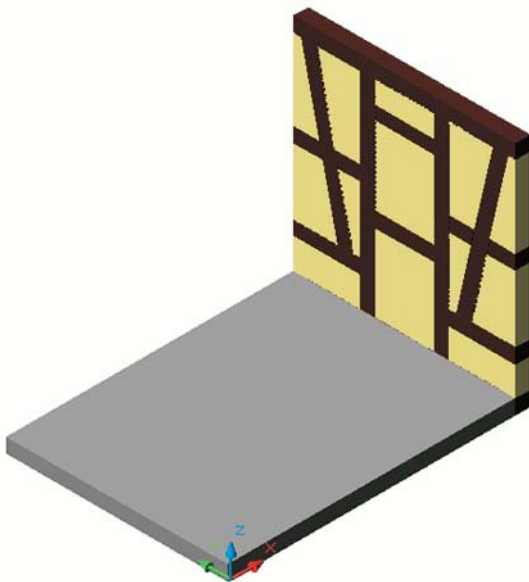
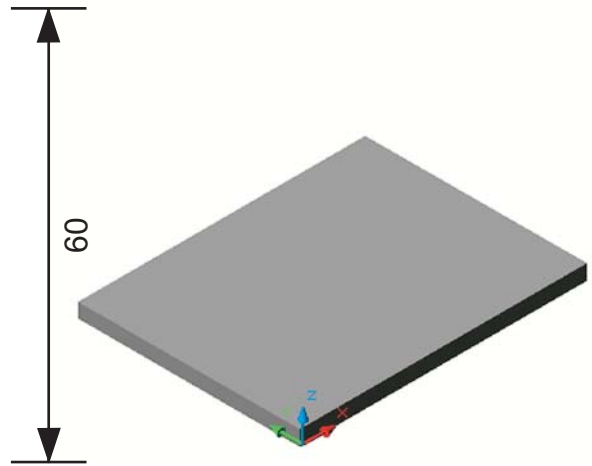
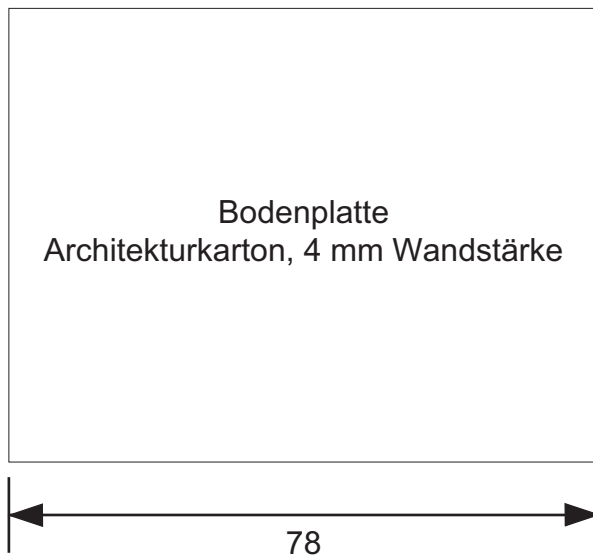

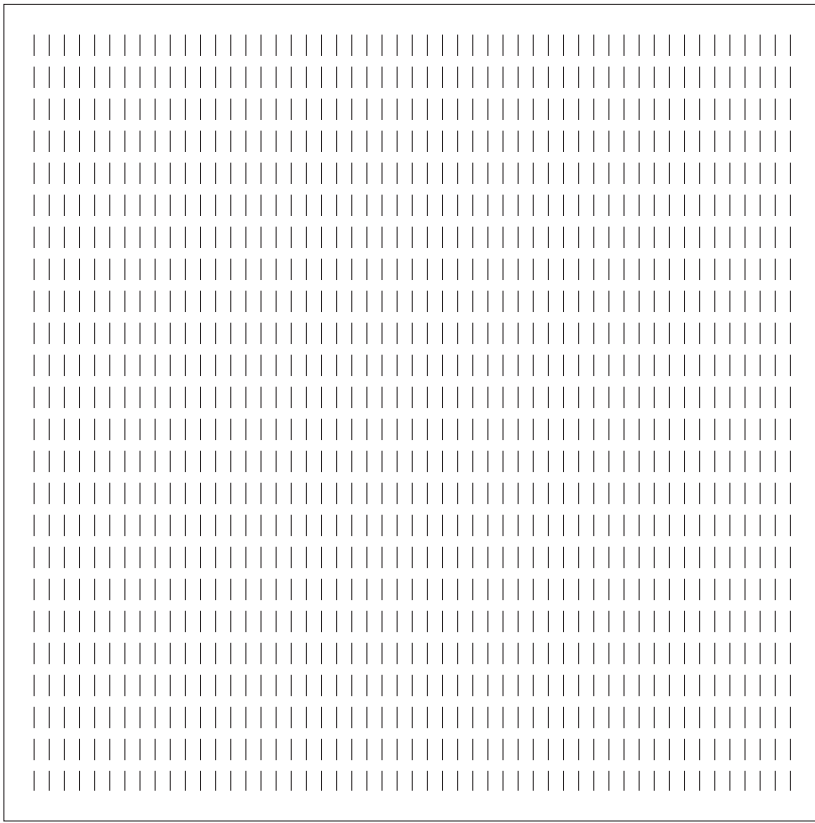

Holzplatte,  
1,6 mm  
Wandstärke,  
2 mm  
Bretterabstand

108

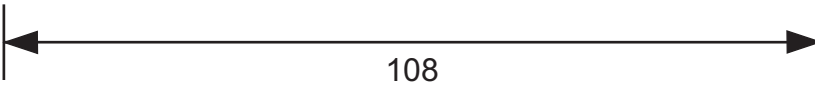

108

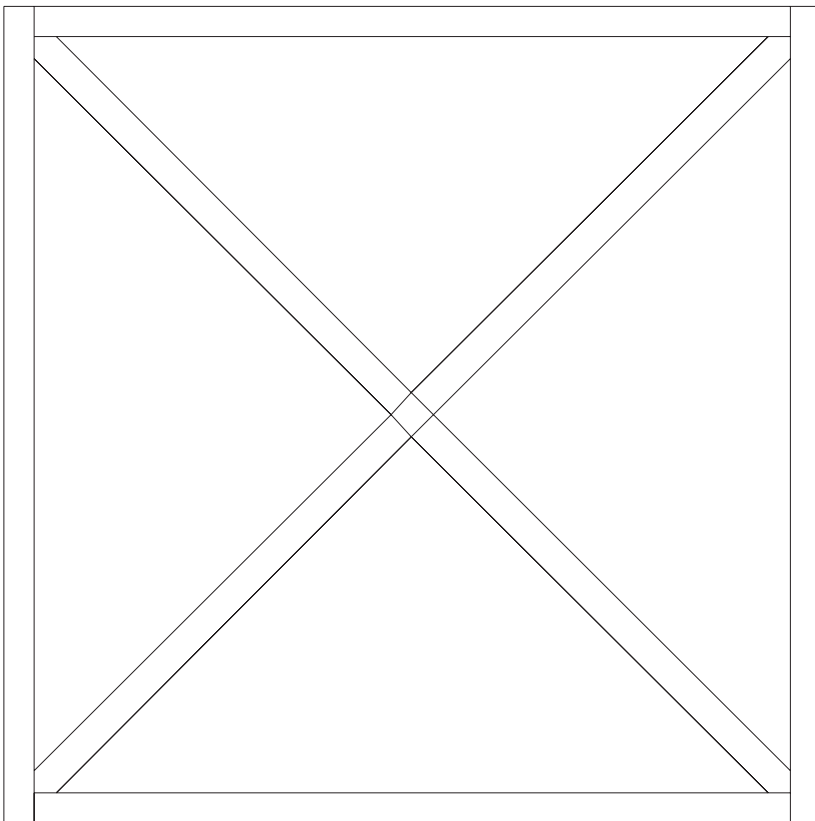

Vierkantstab,  
4 x 4 mm,  
gebeizt

108

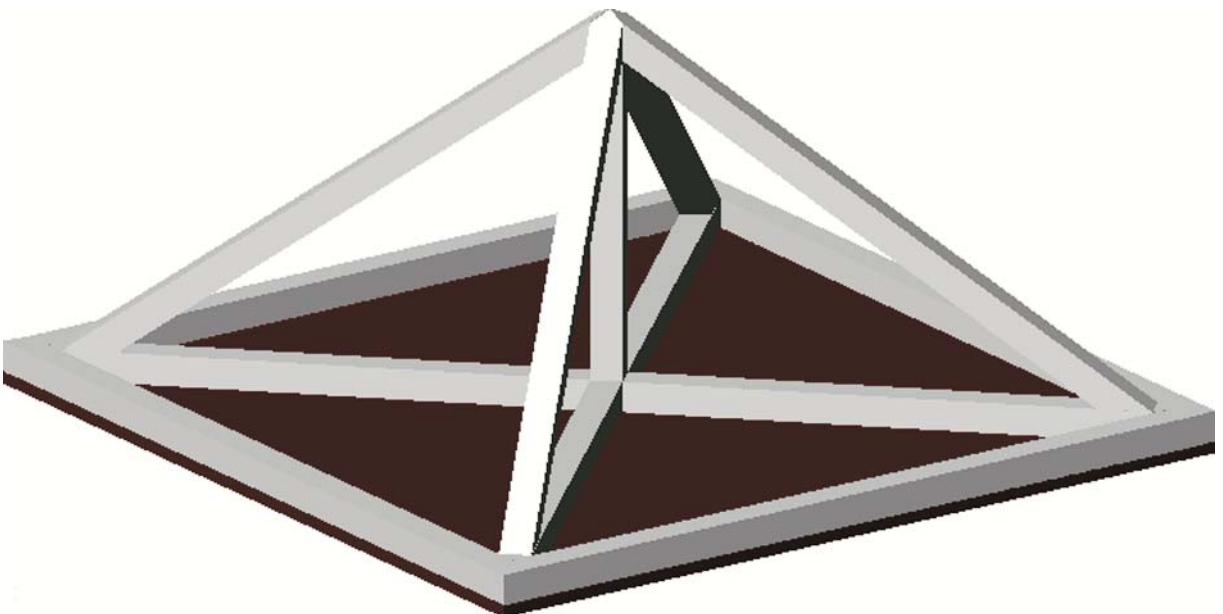
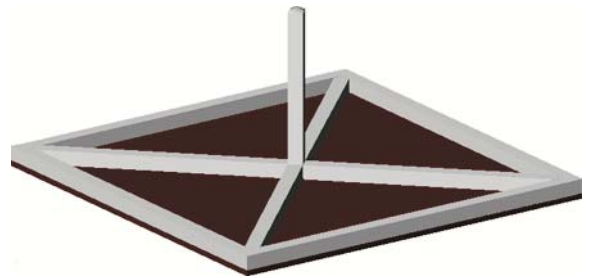
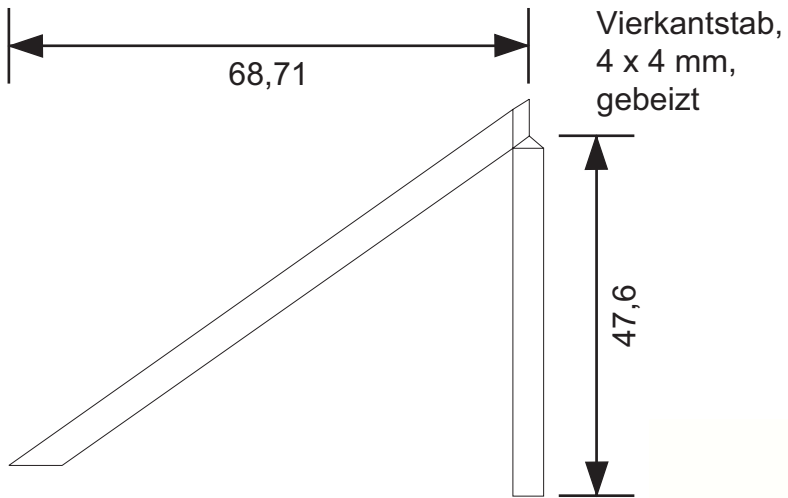
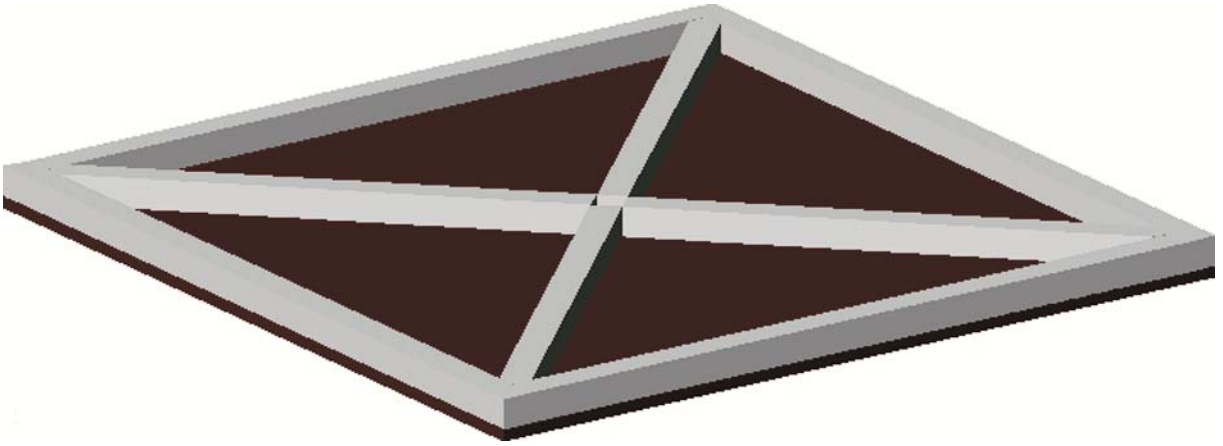

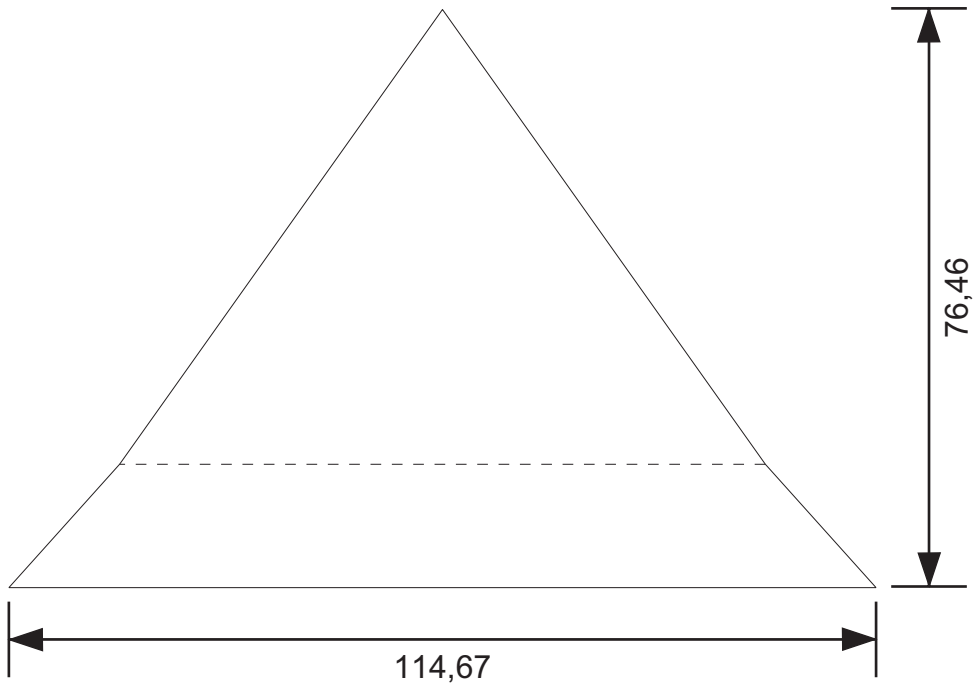

Zuschnitt für Biberschwanz-Dachplatten und Firstziegel

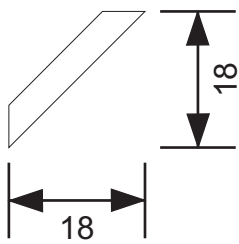

Vierkantstab, 2 x 4 mm, gebeizt

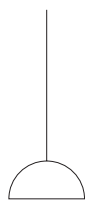

aus der Bastelkiste

